

ASSEMBLY INSTRUCTIONS

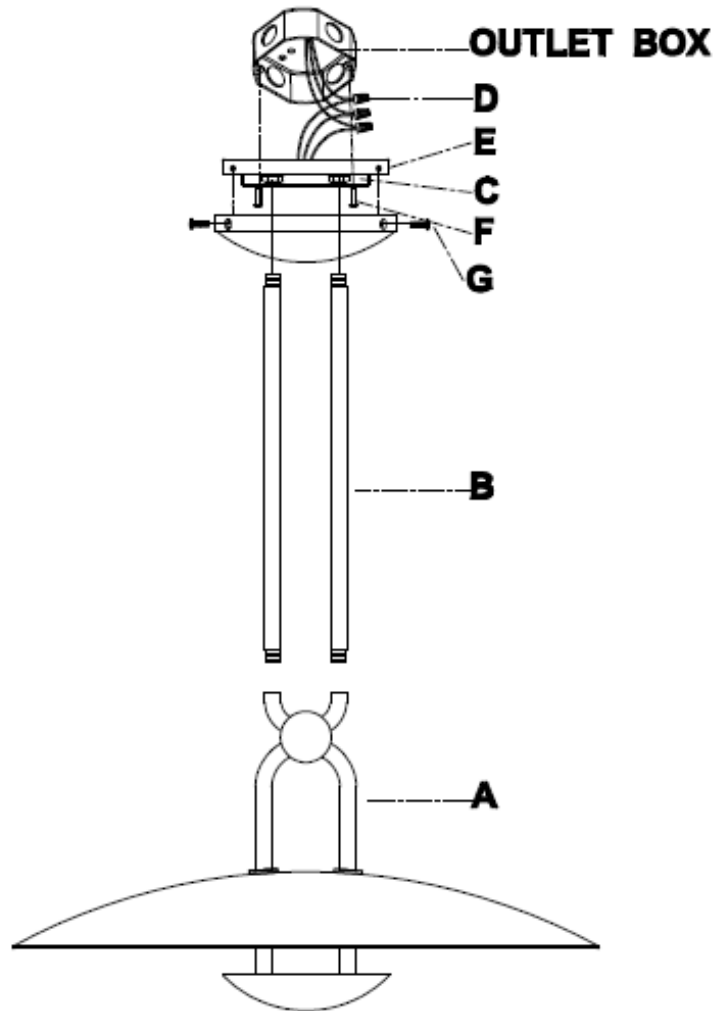

Cara Large Sculpted Pendant # RL5042

WE RECOMMEND INSTALLATION OF THIS LIGHTING FIXTURE BE DONE BY A LICENSED ELECTRICIAN.

WARNING*SWITCH OFF THE MAIN ELECTRICAL SUPPLY FROM THE MAIN FUSE BOX/CIRCUIT BREAKER BEFORE INSTALLATION.**

INSPECT ITEM CAREFULLY BEFORE ATTEMPTING TO INSTALL. IF THERE IS ANY DAMAGE OR OBVIOUS DEFECT. DO NOT INSTALL.

ITEM MAY NOT BE RETURNED ONCE IT HAS BEEN INSTALLED.

NOTE: CAREFULLY UNPACK EACH PIECE IN TOP LAYER OF PACKING PRIOR TO REMOVING. RETAIN ALL PACKING MATERIAL UNTIL INSPECTION AND INSTALLATION ARE FINAL.

1. Carefully remove all parts from the box.
2. Screw off the mounting plate (E) from the canopy by screws (G).
3. Pass cord from fixture (A) through the tube (B) and thread the tube (B) to fixture (A).
4. Put the canopy and mounting plate (E) through the tubes (B), fix the tubes to the mounting plate (E) with the nut (C).
5. Connect the ground wire from fixture (A) to the ground wire from ceiling box.
IT IS IMPERATIVE THAT THIS FIXTURE BE GROUNDED.
6. Connect the hot wire from fixture (A) to the hot wire from ceiling box using wire nuts (D).
7. Repeat this procedure for the neutral wire from the fixture to the neutral wire from ceiling box using wire nuts (D).
8. DO NOT REVERSE THE HOT AND NEUTRAL CONNECTIONS OR SAFETY WILL BE COMPROMISED.
9. Install the mounting plate (E) to the outlet box on the ceiling with screw (F).
10. Install the canopy to the mounting plate (E) with screw (G).
11. Installation is complete, turn on power at fuse or circuit breaker.

***Clean with a dry, soft cloth only. Use no harsh abrasives or chemical agents.

