

ASSEMBLY INSTRUCTIONS

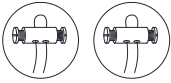

TO assemble safety cables:

1. Join fixture safety cables with safety cable from ceiling.
2. Wrap both safety cable around the cable lock nut.
3. Insert screws into both holes on cable lock nut, secure screws with screwdriver.
4. Push the cable lock nut into outlet box.

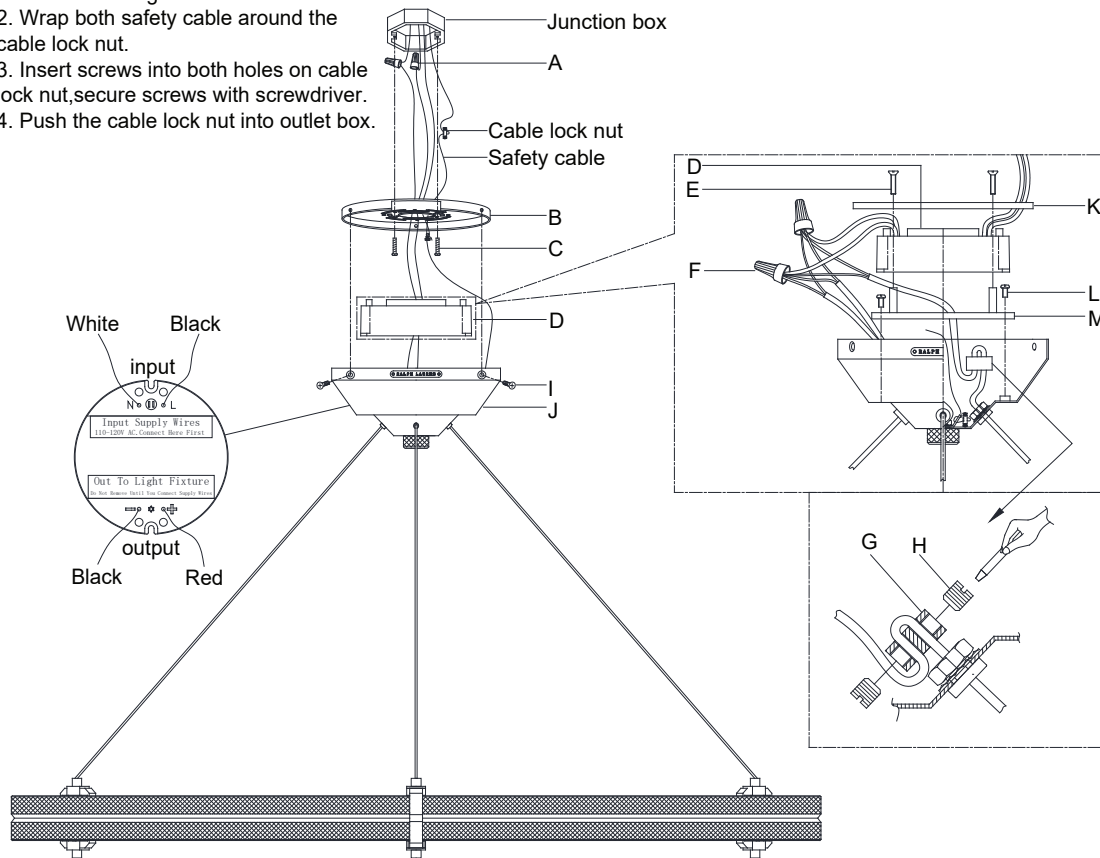

Paxton 40" Ring Chandelier

Item # RL 5672

WE RECOMMEND INSTALLATION OF THIS LIGHTING FIXTURE BE DONE BY A LICENSED ELECTRICIAN.

WARNING*SWITCH OFF THE MAIN ELECTRICAL SUPPLY FROM THE MAIN FUSE BOX/CIRCUIT BREAKER BEFORE INSTALLATION.**

INSPECT ITEM CAREFULLY BEFORE ATTEMPTING TO INSTALL. IF THERE IS ANY DAMAGE OR OBVIOUS DEFECT. DO NOT INSTALL.

ITEM MAY NOT BE RETURNED ONCE IT HAS BEEN INSTALLED.

NOTE: CAREFULLY UNPACK EACH PIECE IN TOP LAYER OF PACKING PRIOR TO REMOVING. RETAIN ALL PACKING MATERIAL UNTIL INSPECTION AND INSTALLATION ARE FINAL.

1. Carefully remove all parts from the box.
2. Remove the mounting plate (B) from the canopy (J) by unscrewing the canopy screws (I).
3. Install the mounting plate (B) to the junction box and secure with mounting screws (C).
4. Wrap the junction box ground wire to the green ground screw on the mounting plate (B) and secure.
IT IS IMPERATIVE THAT THIS FIXTURE BE GROUNDED.
5. Loosen the screws (H) on the wire stopper (G), adjust the length of the fixture hanging wire to the desired length, then secure the screws (H) using the wrench .
6. Measure the wires then cut, be certain to leave enough length to connect the driver output wires.
7. Strip the insulation on the fixture wires about 5/8".
8. Install the heat sink plate (M) to the canopy (J) and secure with screws (L), then install the driver (D) to the heat sink plate (M) and secure with other heat sink plate (K) using the screws (E).
9. Connect the fixture black wires to the driver output black wire using the wire nut (F).
10. Connect the fixture red wires to the driver output red wire using the wire nut (F).
11. Connect the safety cables as shown in figure.
12. Connect the driver input white wire to the neutral wire in the junction box using the wire nut (A).
13. Connect the driver input black wire to the hot wire in the junction box using the wire nut (A).
DO NOT REVERSE THE HOT AND NEUTRAL CONNECTIONS OTHERWISE SAFETY WILL BE COMPROMISED.

RALPH LAUREN

ASSEMBLY INSTRUCTIONS

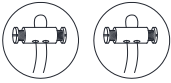

TO assemble safety cables:

1. Join fixture safety cables with safety cable from ceiling.
2. Wrap both safety cable around the cable lock nut.
3. Insert screws into both holes on cable lock nut, secure screws with screwdriver.
4. Push the cable lock nut into outlet box.

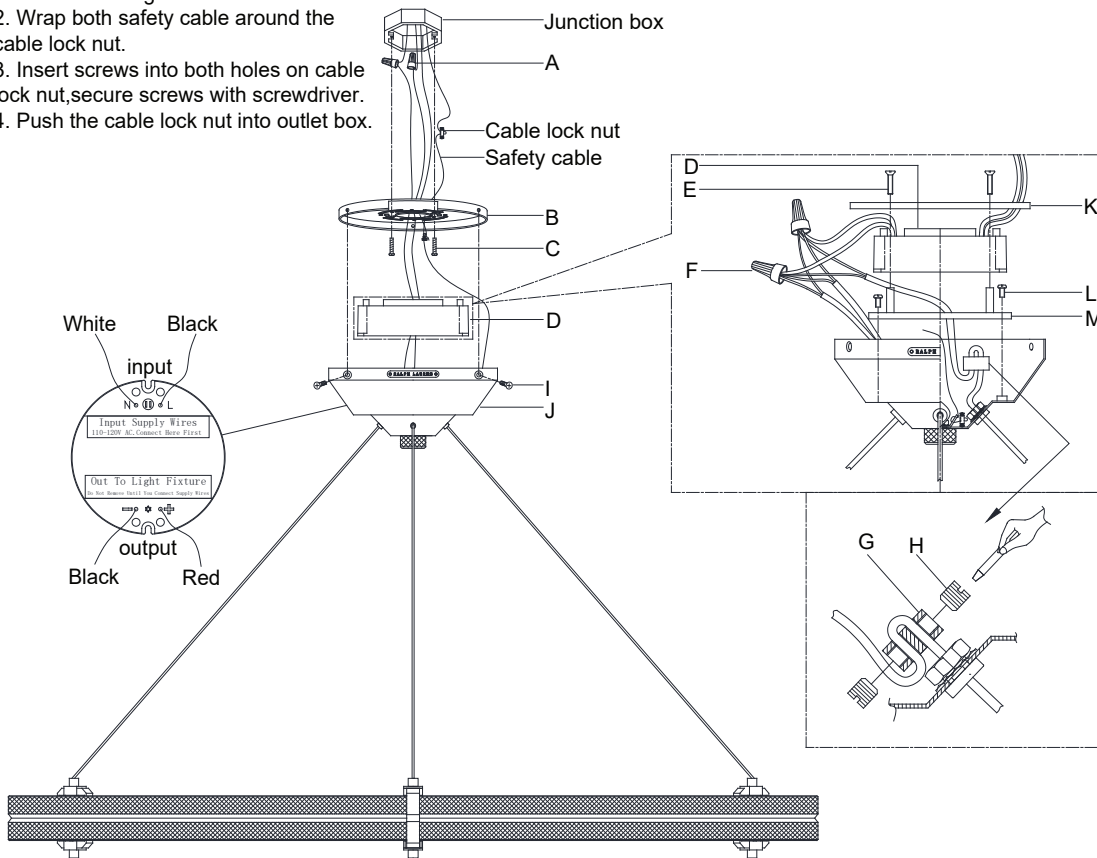

Paxton 40" Ring Chandelier

Item # RL 5672

WE RECOMMEND INSTALLATION OF THIS LIGHTING FIXTURE BE DONE BY A LICENSED ELECTRICIAN.

WARNING*SWITCH OFF THE MAIN ELECTRICAL SUPPLY FROM THE MAIN FUSE BOX/CIRCUIT BREAKER BEFORE INSTALLATION.**

INSPECT ITEM CAREFULLY BEFORE ATTEMPTING TO INSTALL. IF THERE IS ANY DAMAGE OR OBVIOUS DEFECT. DO NOT INSTALL.

ITEM MAY NOT BE RETURNED ONCE IT HAS BEEN INSTALLED.

NOTE: CAREFULLY UNPACK EACH PIECE IN TOP LAYER OF PACKING PRIOR TO REMOVING. RETAIN ALL PACKING MATERIAL UNTIL INSPECTION AND INSTALLATION ARE FINAL.

14. Carefully tuck the wire connections into the junction box.
15. Install the canopy (J) to the mounting plate (B) and secure with the canopy screws (I).
16. Remove the protective film on the fixture body carefully.
17. Installation is complete, turn on power at fuse or circuit breaker.

***Clean with a dry, soft cloth only. Use no harsh abrasives or chemical agents.

RALPH LAUREN